

Verschluss ohne Schließblech

| A | B | C | Artikel-Nr. | Material | Dekor | Gewicht |
|------|------|------|-------------|------------------|-------------|---------|
| 62.5 | 24.6 | 14.2 | 16-7-3897 | Edelstahl 1.4301 | unbehandelt | 27g |

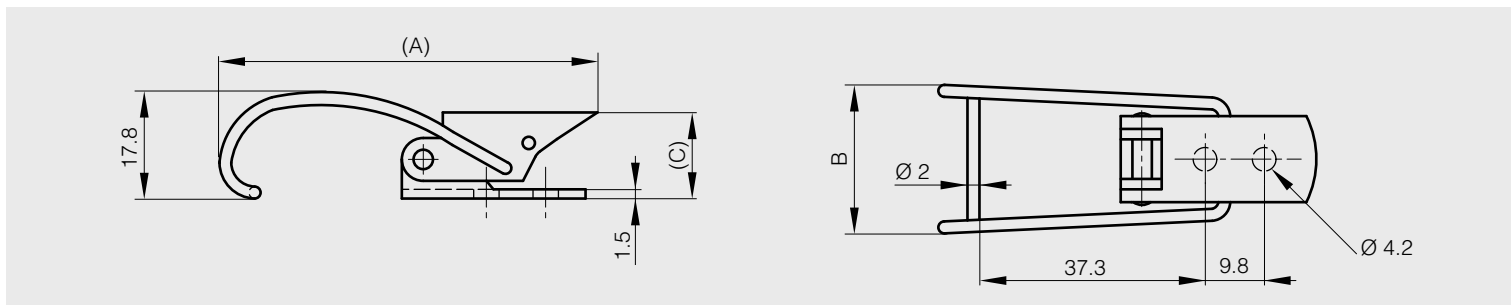

| A | B | C | Artikel-Nr. | Material | Dekor | Gewicht |
|------|------|------|-------------|------------------|-------------|---------|
| 62.5 | 24.4 | 13.5 | 16-7-3900 | Edelstahl 1.4301 | unbehandelt | 27g |

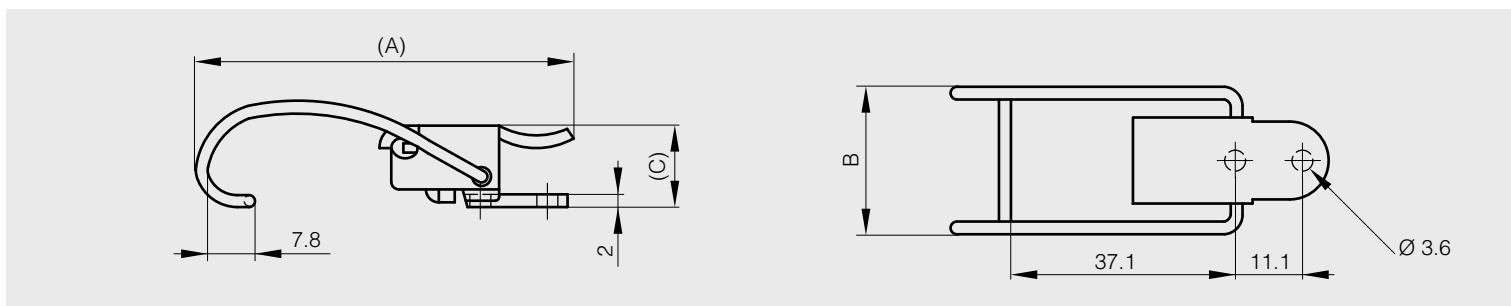



Verschluss ohne Schließblech

| A | B | C | Artikel-Nr. | Material | Dekor | Gewicht |
|------|------|------|-------------|----------|------------------------------------|---------|
| 63.6 | 22.5 | 11.8 | 16-7-3767 | Stahl | schwarz kataphoresisch beschichtet | 20g |

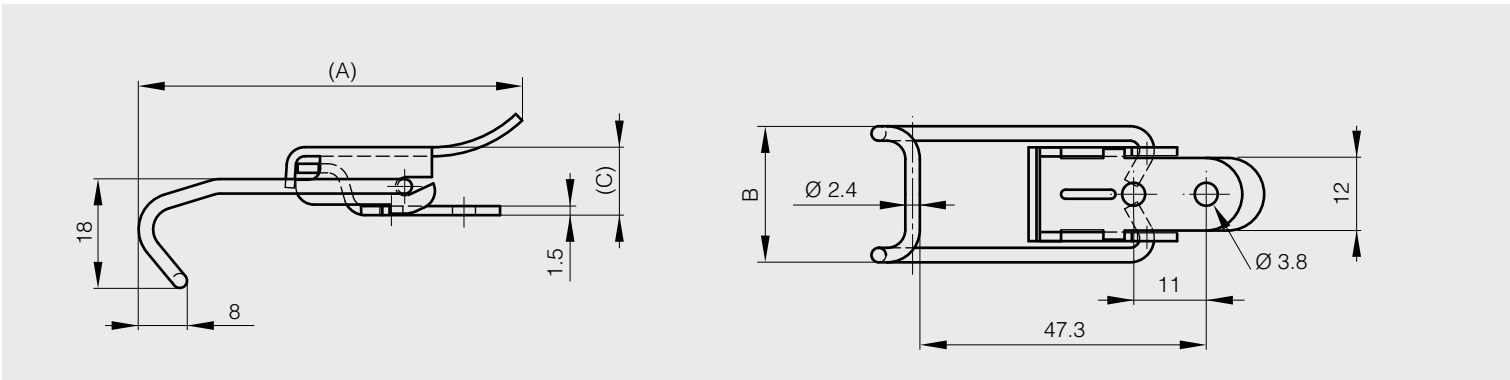

| A | B | C | Artikel-Nr. | Material | Dekor | Gewicht |
|----|------|----|-------------|-----------|-------------|---------|
| 64 | 28.7 | 14 | 16-7-3947 | Stahl | verzinkt | 45g |
| 64 | 28.7 | 14 | 16-7-3948 | Edelstahl | unbehandelt | 45g |

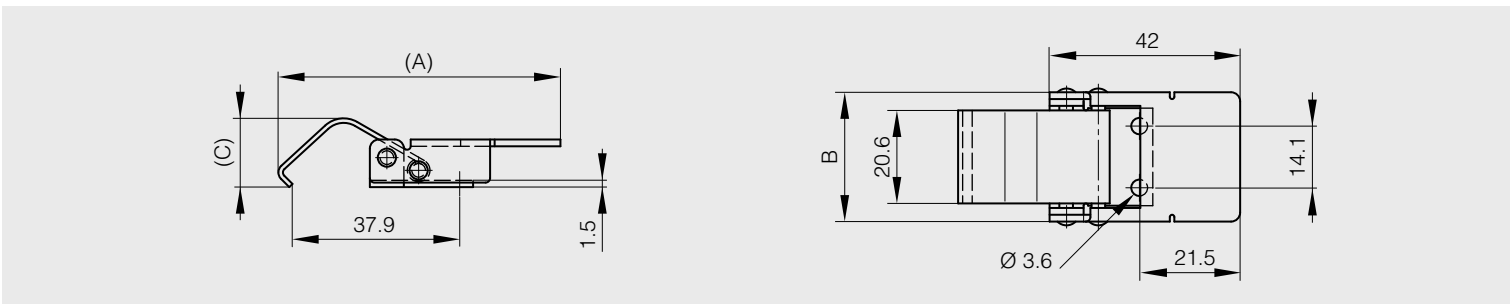

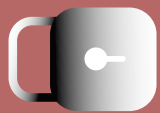

Verschlüsse ohne Schließblech

| A | B | C | Artikel-Nr. | Material | Dekor | Gewicht |
|------|------|------|-------------|------------------|-------------|---------|
| 67.6 | 25.4 | 13.7 | 16-7-3901 | Stahl | verzinkt | 32g |
| 67.6 | 25.4 | 13.7 | 16-7-3902 | Edelstahl 1.4301 | unbehandelt | 32g |

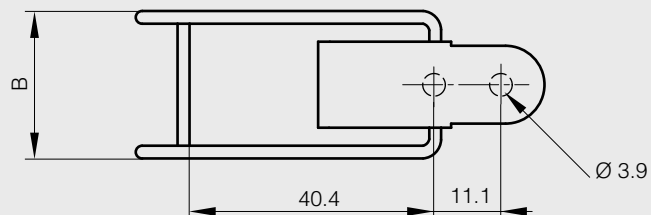
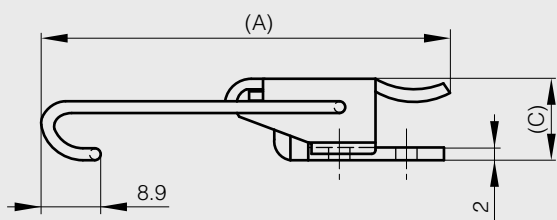

| A | B | C | Artikel-Nr. | Material | Dekor | Gewicht |
|------|------|------|-------------|------------------|-------------|---------|
| 93.2 | 25.4 | 13.7 | 16-7-3903 | Edelstahl 1.4301 | unbehandelt | 32g |

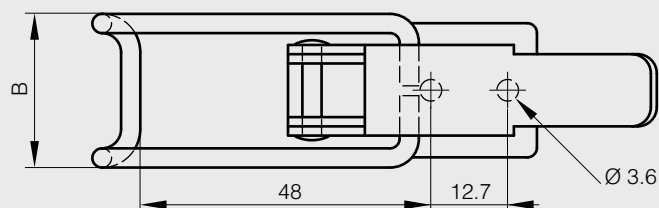
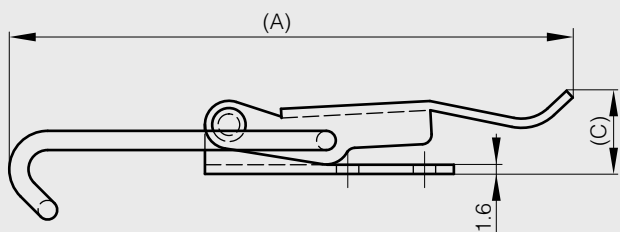

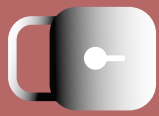

Verschluss ohne Schließblech

| A | B | C | Artikel-Nr. | Material | Dekor | Gewicht |
|-----|----|------|-------------|----------|------------------------------------|---------|
| 106 | 47 | 19.5 | 16-7-3768 | Stahl | schwarz kataphoresisch beschichtet | 42g |

